

# ŞASELİ MOBİL İSKELE SİSTEMLERİ

## MOBILE SCAFFOLDING WITH CHASSIS SYSTEMS



**OĞUZHAN**  
çelik iskele ve kalıp san a.ş.

SINCE'87

Fabrika

:Çalıcı OSB Mah. Adnan Menderes

Bulvarı No:8 Bucak/Burdur

Telefon

:+90 248 325 35 55 /+90 248 325 13 84

Fax

:+90 248 325 91 91

Web

:www.oguzhaniskele.com

e-mail

:bilgi@oguzhaniskele.com

TS EN 74

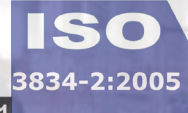

TS EN 12810-1



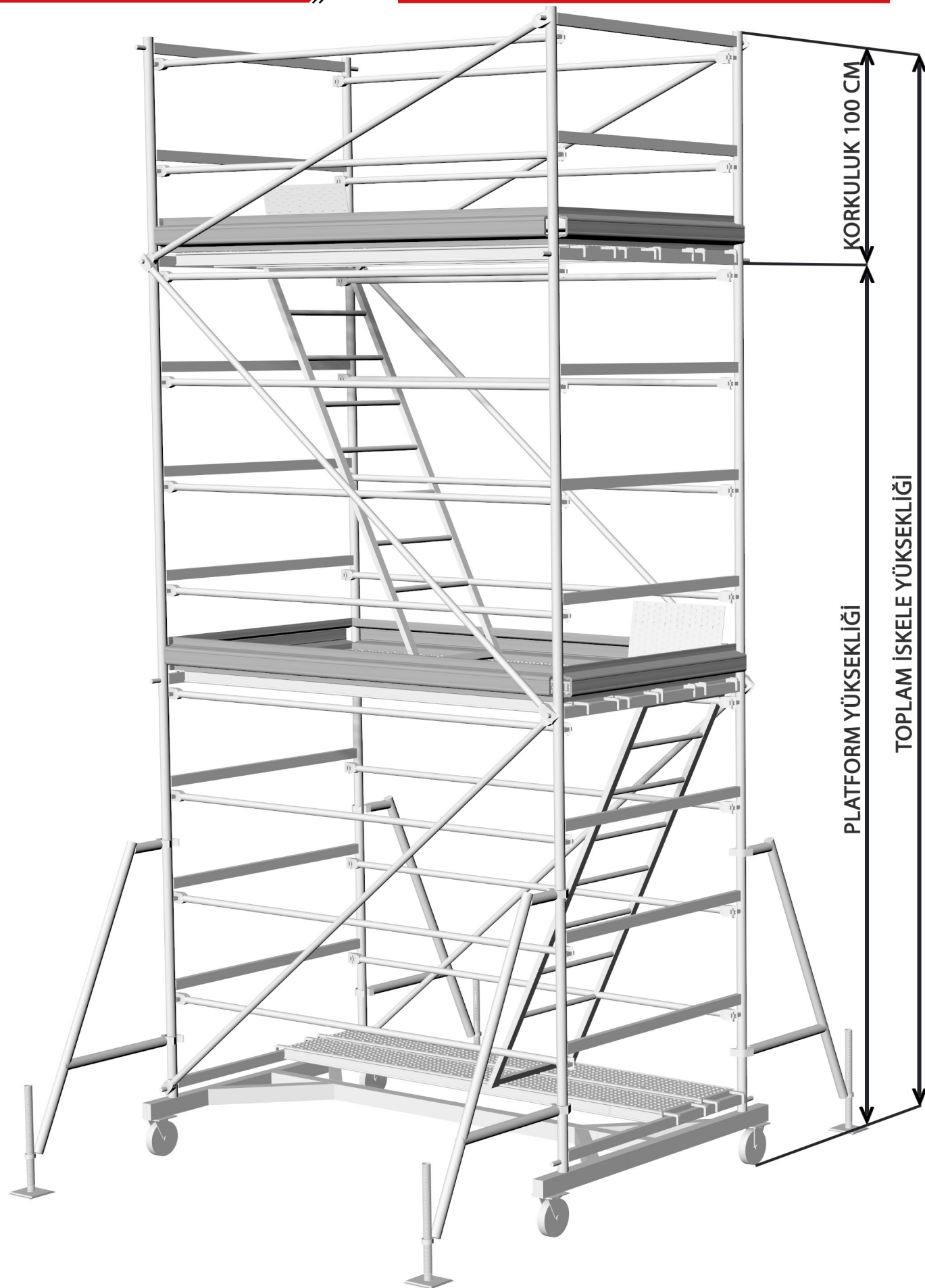

## GENEL BİLGİLER /GENERAL INFORMATION

**T**ekerlekli Mobil İskele nedir? Tekerlekli Şaseli mobil iskele sistemi, Boya işleri, alçı işleri, sıva işleri, mantolama işleri gibi her türlü ince inşaat işlerinde, tadilat işlerinde, temizlik işlerinde, endüstriyel yapılarda ve depolarda rahatlıkla kullanılabilir.

**Tekerlekli İskele Sistemi :** Tekerlekli Profil Taban, H Tipi Merdivenli Çerçeve, Yatay Çubuk, Çapraz Çubuk, Sac Kalas, Kapaklı Kalaslı Merdiven, H Tipi Merdivenli Korkuluk Çerçeve, Tekmelik ve Yan Destek Payandasından oluşur. 135/250 Ortadan Bağlantılı, 200/250 Kenardan Bağlantılı olmak üzere 2 farklı türde üretimi yapılmaktadır.

H Tipi Merdivenli Çerçevelerde karşılıklı olacak şekilde toplamda 10 adet pimli kilit sistemi bulunmaktadır. Pimler, yatay elemanların bağlantıları için iç kısma bakacak şekilde 8 adet, çapraz elemanların yerleştirilmesi için dışa bakacak şekilde 2 adettir.

Tekerlekli Şaseli Mobil İskele Sistemi, tekerlekli yapısı sayesinde istenilen her yöne hareket edebilme kabiliyetine sahiptir. İskele sisteminin boyu, çalışma koşullarına göre istenilen yüksekliğe göre ayarlanabilir. Kurulumu kolay ve pratiktir. Kurulumu yapılırken ek iş gücü oluşturmaya, zorlanmaya gerek yoktur. Pimli kilit sistemi sayesinde montajı hızlı olduğundan işgücünden tasarruf edilir.

Tekerlekli Mobil İskele Sistemi Malzemeleri, OĞUZHAN® markalı olarak TSE EN ISO 3834-2 Metalik Malzemelerin Ergitme Kaynağı İçin Kalite Şartları Standardına uygundur.

İskele sisteminin üretiminde kullanılan borular, mekanik ve kimyasal testleri yapılmış, TSE EN 10219-2 Yapısal Çelik Boru Standardına uygun borulardır.

**W**hat is Wheeled Mobile Scaffolding? Wheeled Chassis mobile scaffolding system can be easily used in all kinds of fine construction works such as paint works, plaster works, plaster works, sheathing works, renovation works, cleaning works, industrial structures and warehouses. Wheeled Scaffolding System: It consists of Wheeled Profile Base, H Type Ladder Frame, Horizontal Bar, Cross Bar, Sheet Metal Plank, Covered Board Ladder, H Type Stair Railing Frame, Toe Board and Side Support Strut. It is produced in 2 different types as 135/250 Middle Connected and 200/250 Side Connected.

H Type Ladder Frames have a total of 10 pin lock systems to be reciprocal. The pins are 8 facing inwards for connecting horizontal members and 2 facing outward for inserting cross members.

Mobile Scaffolding System with Wheeled Chassis has the ability to move in any direction thanks to its wheeled structure. The length of the scaffolding system can be adjusted to the desired height according to the working conditions. It is easy and practical to install. There is no need to create additional labor or force while installing. Thanks to the pin lock system, labor is saved as it is fast to assemble.

Wheeled Mobile Scaffolding System Materials, as OĞUZHAN® brand, comply with TSE EN ISO 3834-2 Quality Requirements Standard for Melting Welding of Metallic Materials.

The pipes used in the production of the scaffolding system are pipes that have undergone mechanical and chemical tests and comply with TSE EN 10219-2 Structural Steel Pipe Standard.

**ŞASELİ MOBİL İSKELE 135x200**  
**MOBILE SCAFFOLDING WITH CHASSIS 135x200**

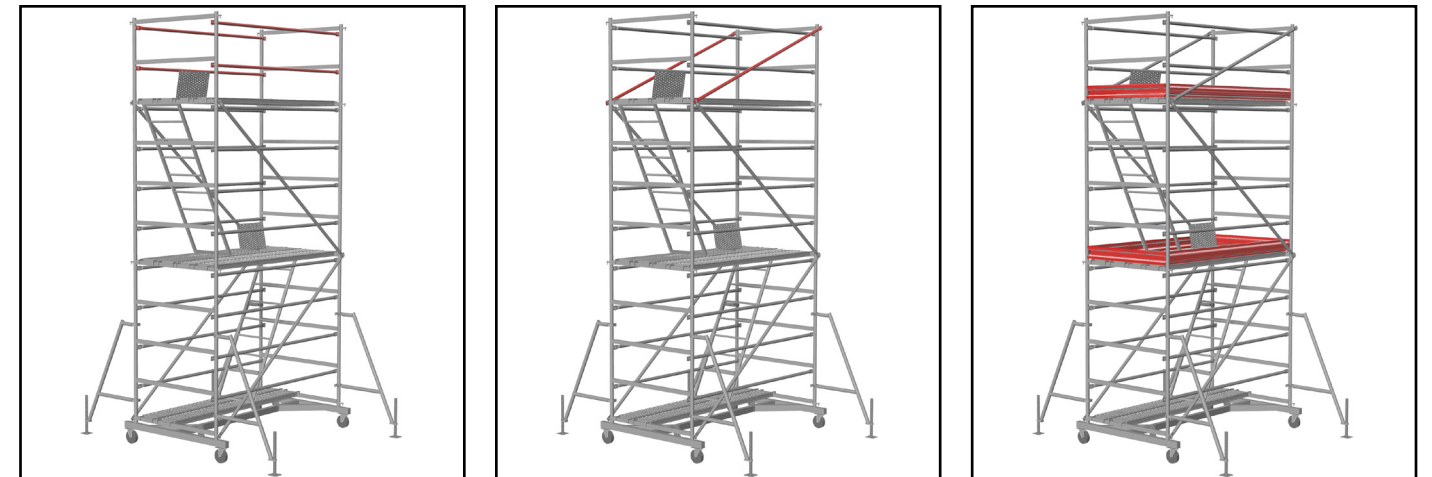
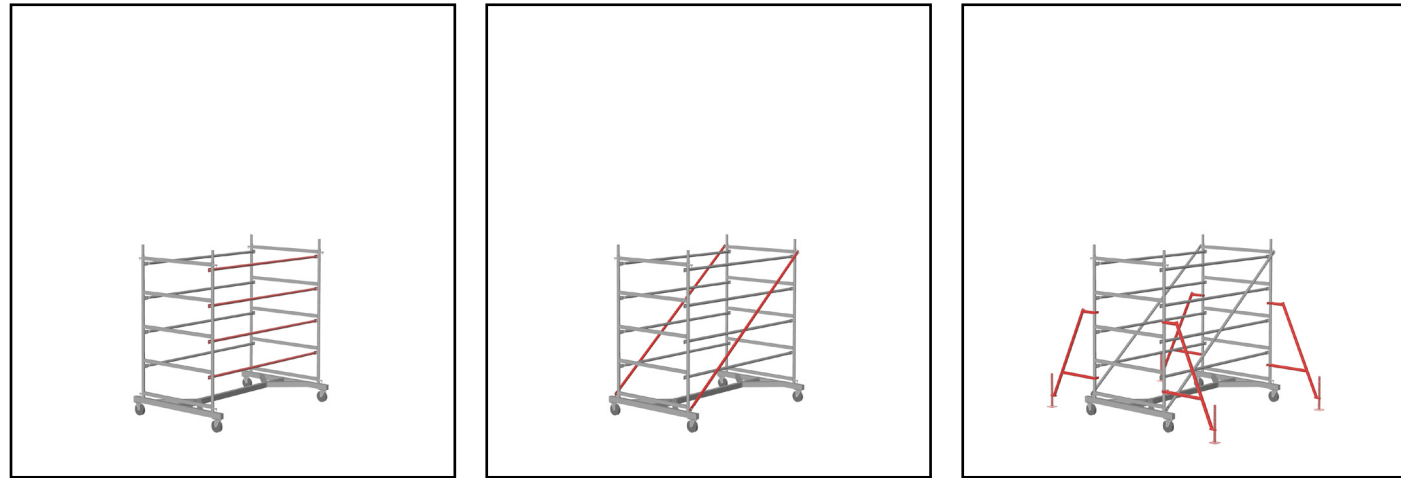
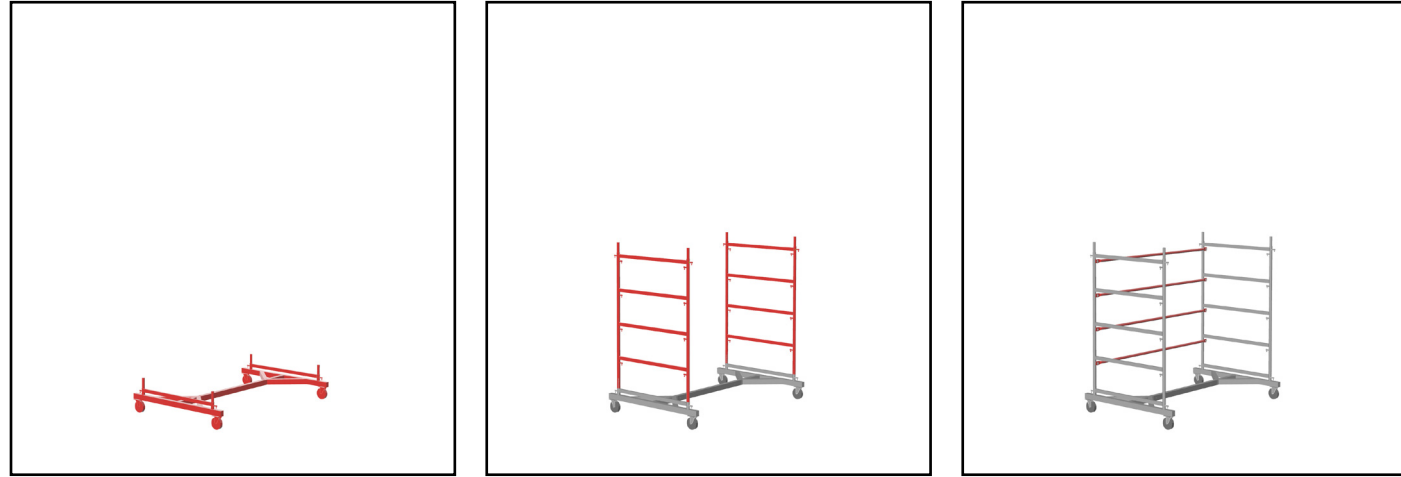

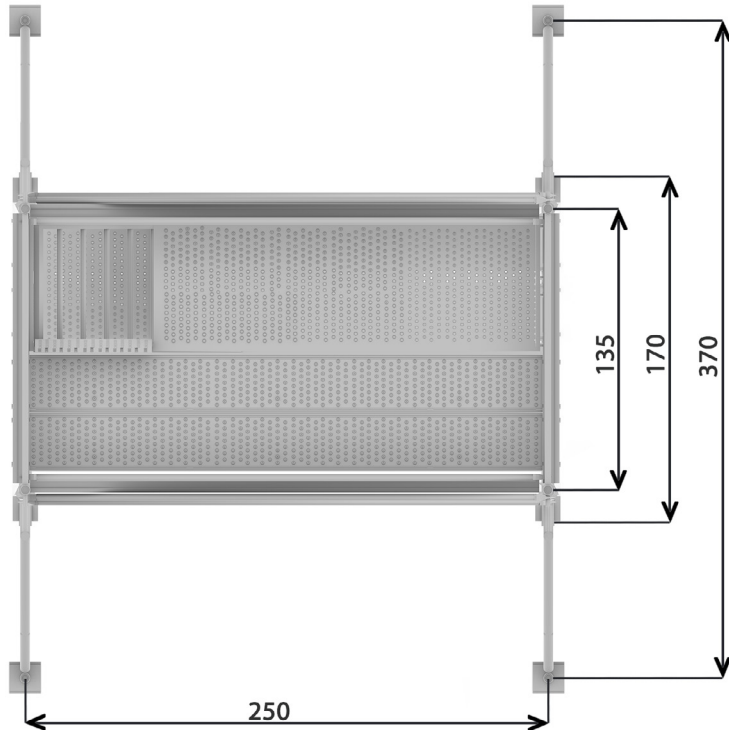
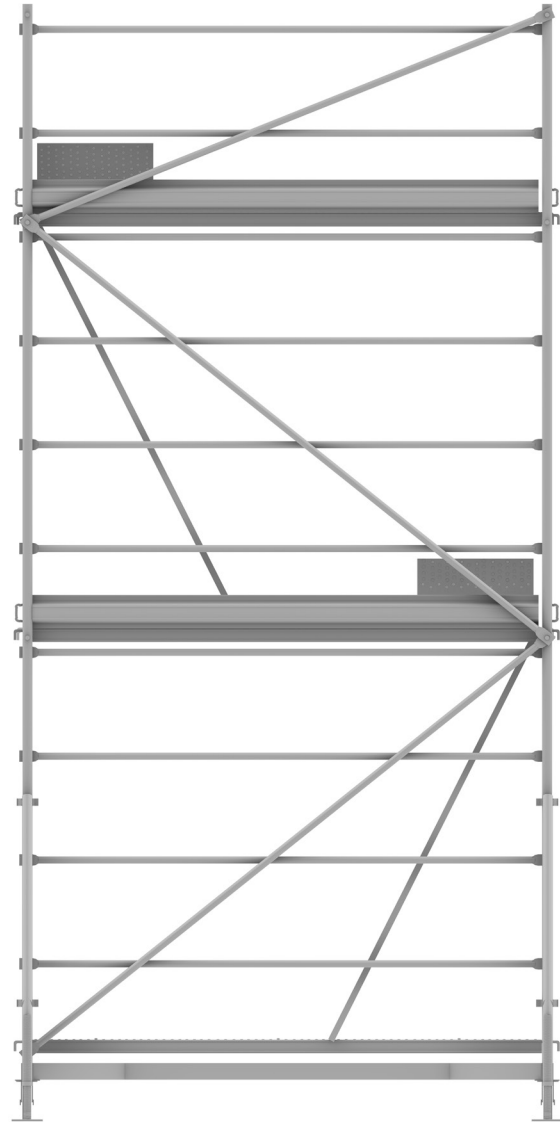
Yan Payanda İş İskelesi İçin  
Side Support For Scaffolding

KOD CODE	BOYUT cm SIZE cm	AĞIRLIK kg WEIGHT kg
EDS001	-	10,00

## ŞASELİ MOBİL İSKELE 135x200 MOBILE SCAFFOLDING WITH CHASSIS 135x200

135/100 H Tipi Merdivenli Çerçeve  
135/100 H Frame With Ladder

KOD CODE	BOYUT cm SIZE cm	AĞIRLIK kg WEIGHT kg
EDB002	135/100	12,80

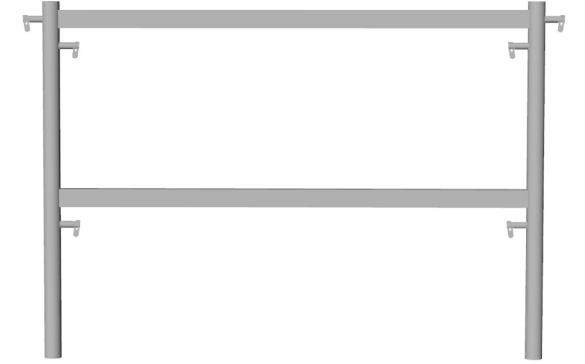
135/200 H Tipi Merdivenli Çerçeve  
135/200 H Frame With Ladder

KOD CODE	BOYUT cm SIZE cm	AĞIRLIK kg WEIGHT kg
EDB001	135/200	26,30

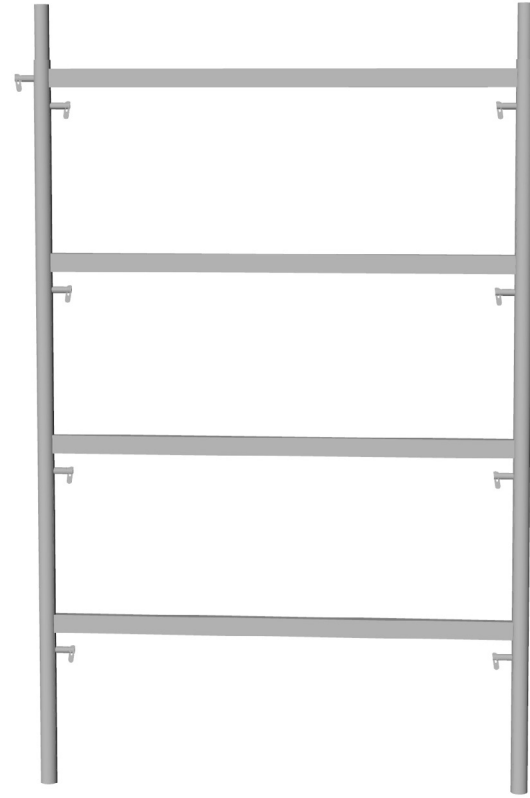
Yatay Çubuk 250  
Horizontal Component 250

KOD CODE	BOYUT cm SIZE cm	AĞIRLIK kg WEIGHT kg
EAG250	250	4,00

Çapraz Eleman 100/250  
Cross Component 100/250

KOD CODE	BOYUT cm SIZE cm	AĞIRLIK kg WEIGHT kg
EDB008	100/250	6,40

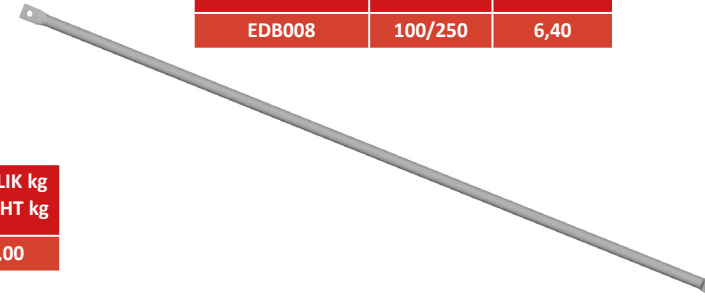
Profil Tekerlekli Taban ve Taban  
Bağlantı Elemanı  
Profile Base With Wheels

KOD CODE	BOYUT cm SIZE cm	AĞIRLIK kg WEIGHT kg
EDB003	170/250	22,75
EDB004	170	6,45

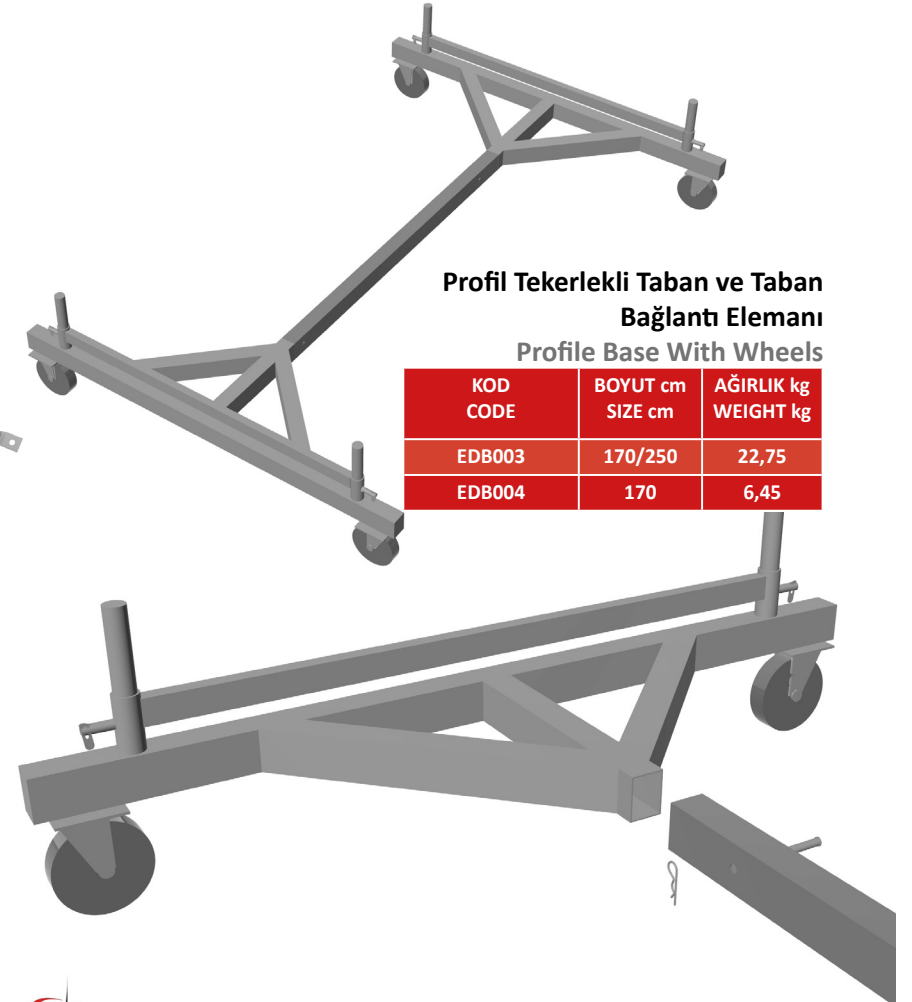
Çapraz Eleman 200/250  
Cross Component 200/250

KOD CODE	BOYUT cm SIZE cm	AĞIRLIK kg WEIGHT kg
EDB009	200/250	7,60

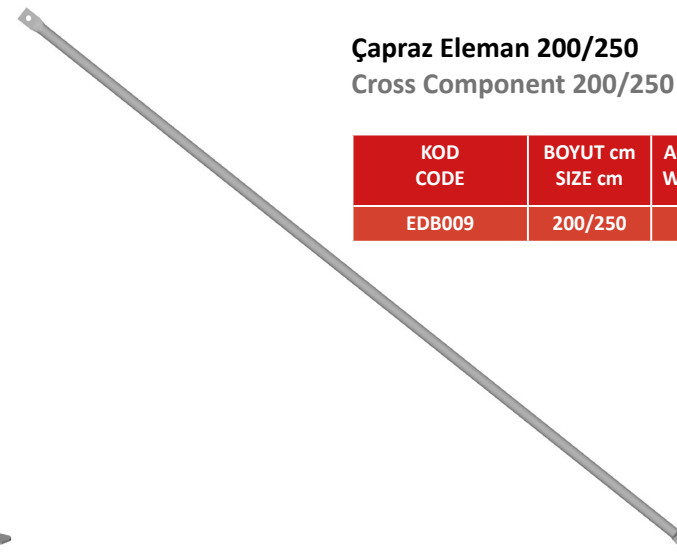



**ŞASELİ MOBİL İSKELE 200x250**  
**MOBILE SCAFFOLDING WITH CHASSIS 200x250**

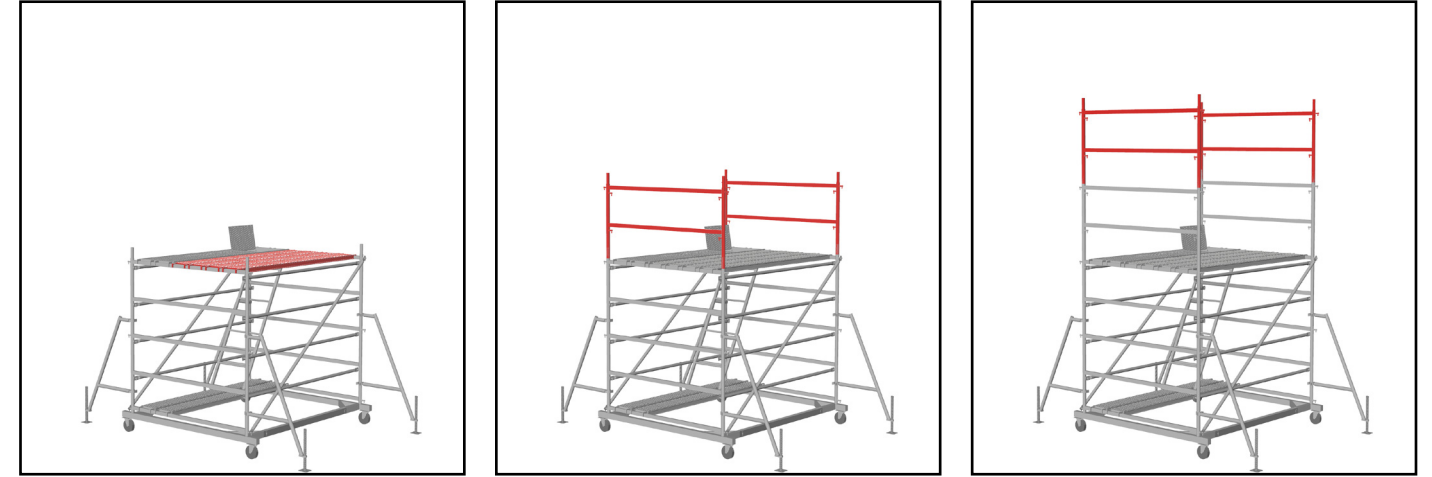
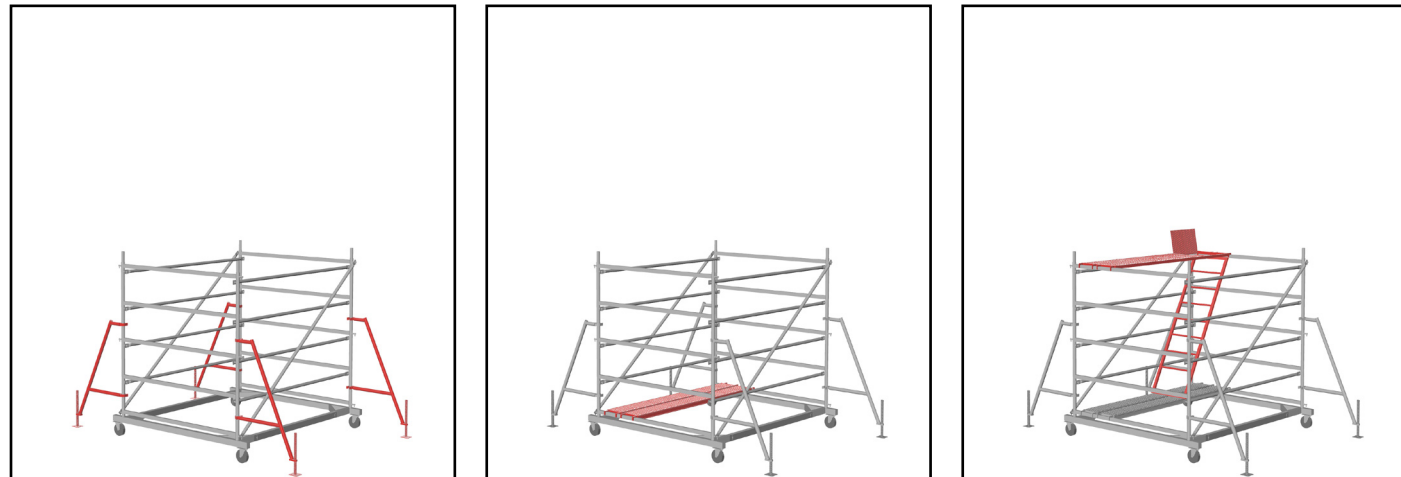
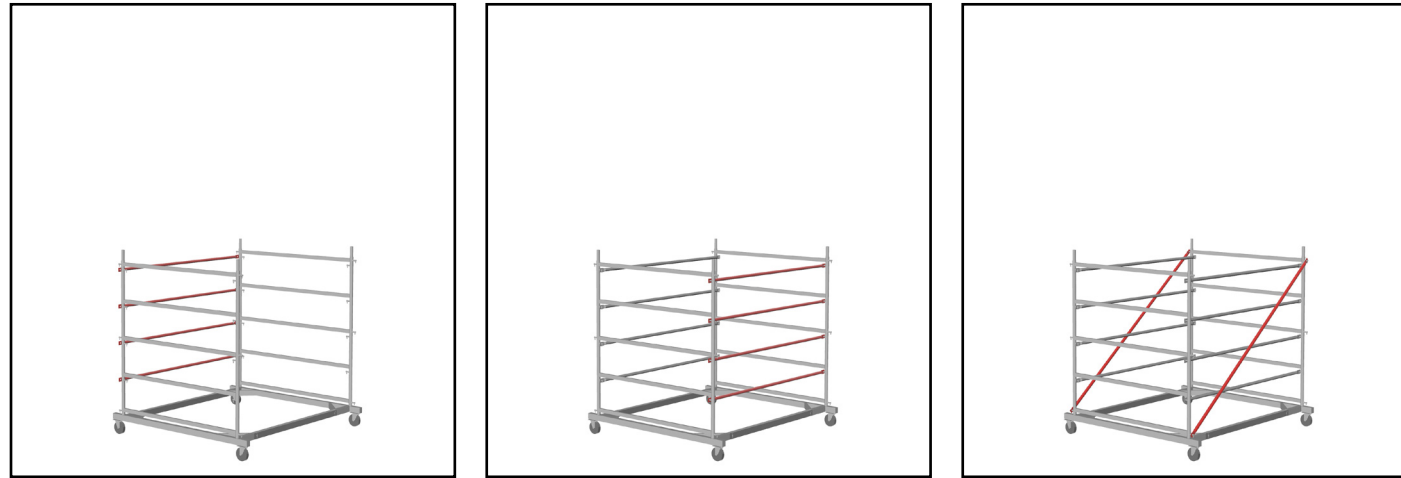
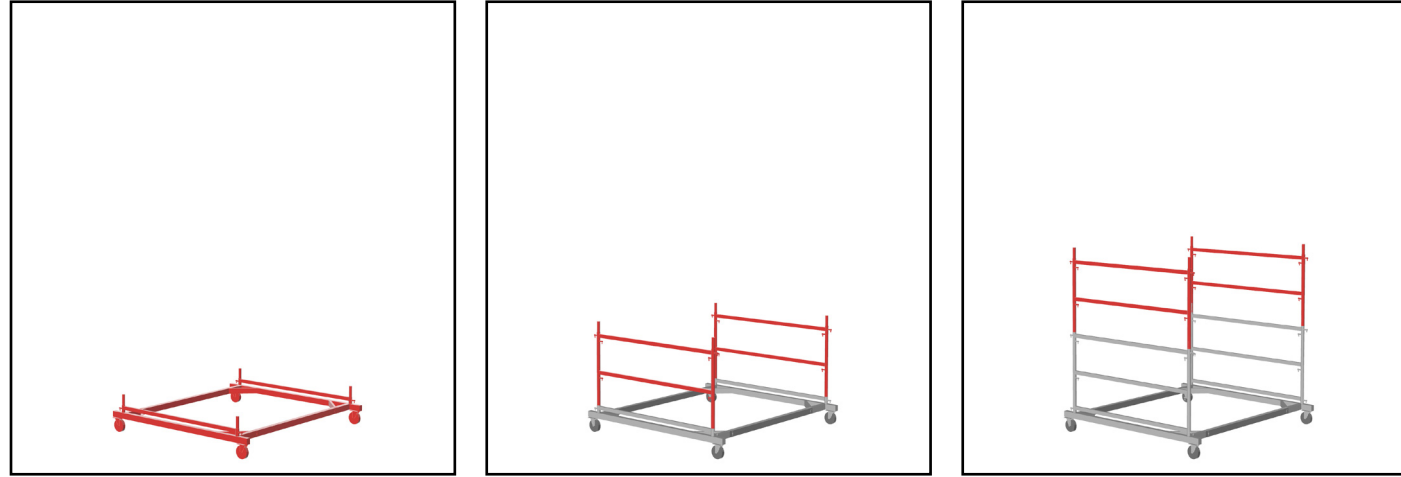

## ŞASELİ MOBİL İSKELE 200x250

### MOBILE SCAFFOLDING WITH CHASSIS 200x250

Yan Payanda İş İskelesi için  
Side Support For Scaffolding

KOD CODE	BOYUT cm SIZE cm	AĞIRLIK kg WEIGHT kg
EDS001	-	10,00

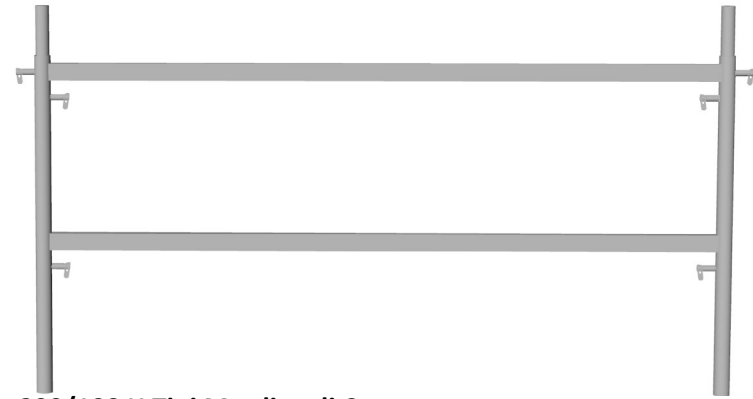

200/100 H Tipi Merdivenli Çerçeve  
0,50 Carters Base jack

KOD CODE	BOYUT cm SIZE cm	AĞIRLIK kg WEIGHT kg
EDB006	200/100	16,50

Yatay Çubuk 250  
Horizontal Component 250

KOD CODE	BOYUT cm SIZE cm	AĞIRLIK kg WEIGHT kg
EAG250	250	4,00



Çapraz Eleman 100/250  
Cross Component 100/250

KOD CODE	BOYUT cm SIZE cm	AĞIRLIK kg WEIGHT kg
EDB008	100/250	6,40

Çapraz Eleman 200/250  
Cross Component 200/250

KOD CODE	BOYUT cm SIZE cm	AĞIRLIK kg WEIGHT kg
EDB009	200/250	7,60



Profil Tekerlekli Taban ve Taban Bağlantı Elemanı  
Profile Base With Wheels

KOD CODE	BOYUT cm SIZE cm	AĞIRLIK kg WEIGHT kg
EDB007	240/250	29,20
EDB004	240	13,20

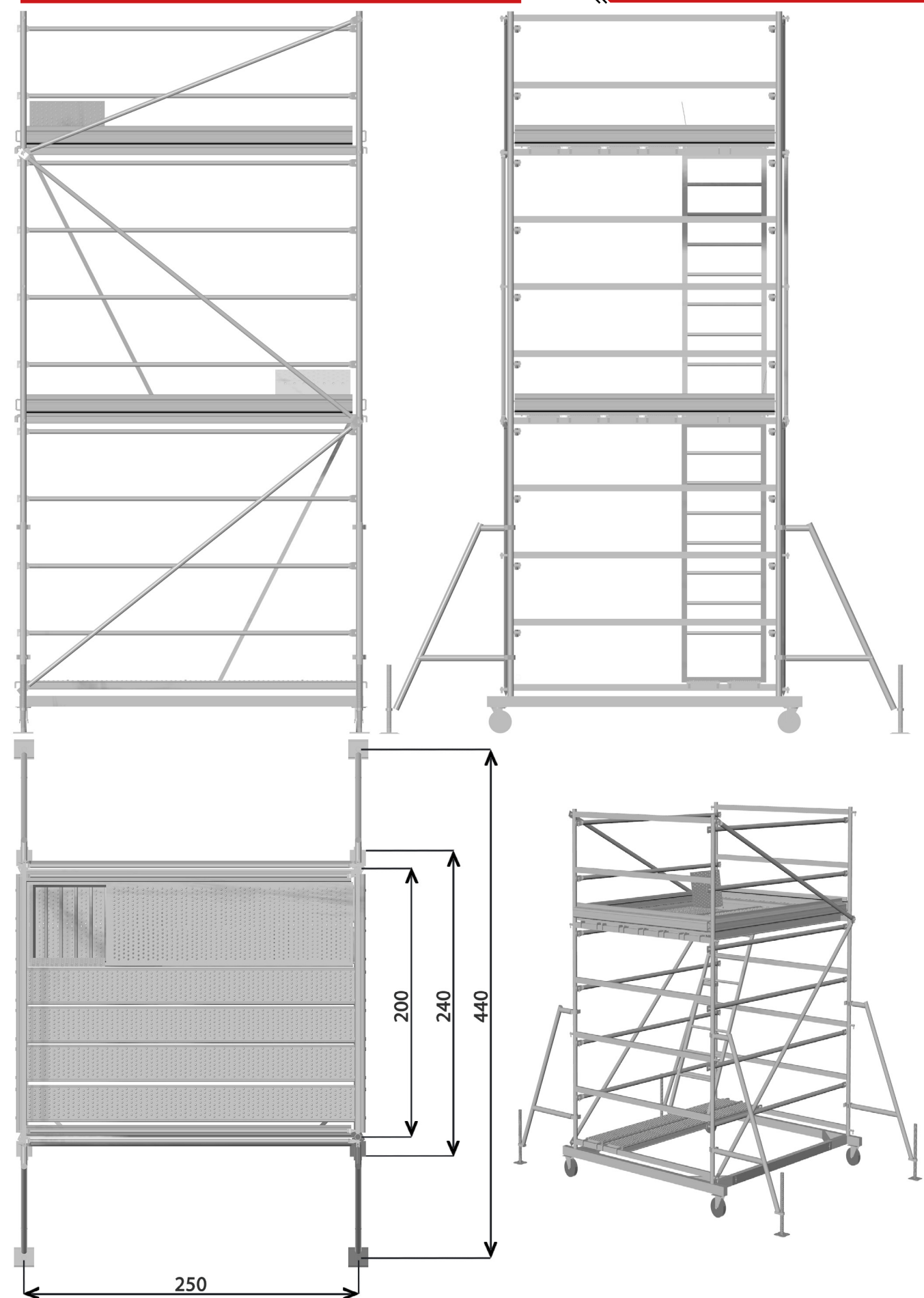
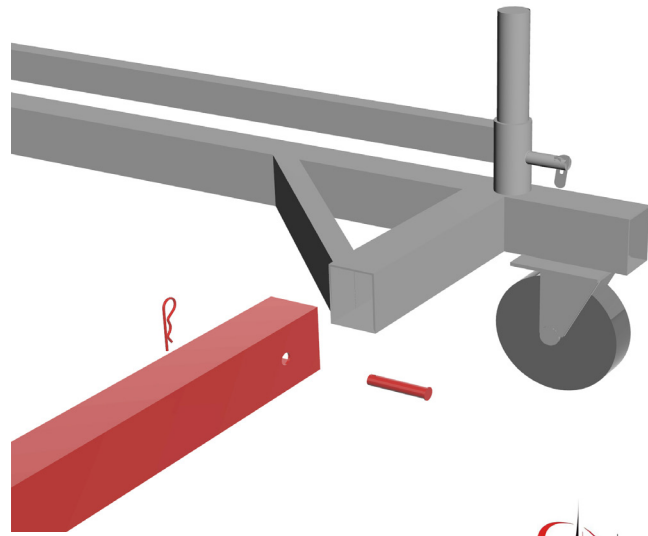

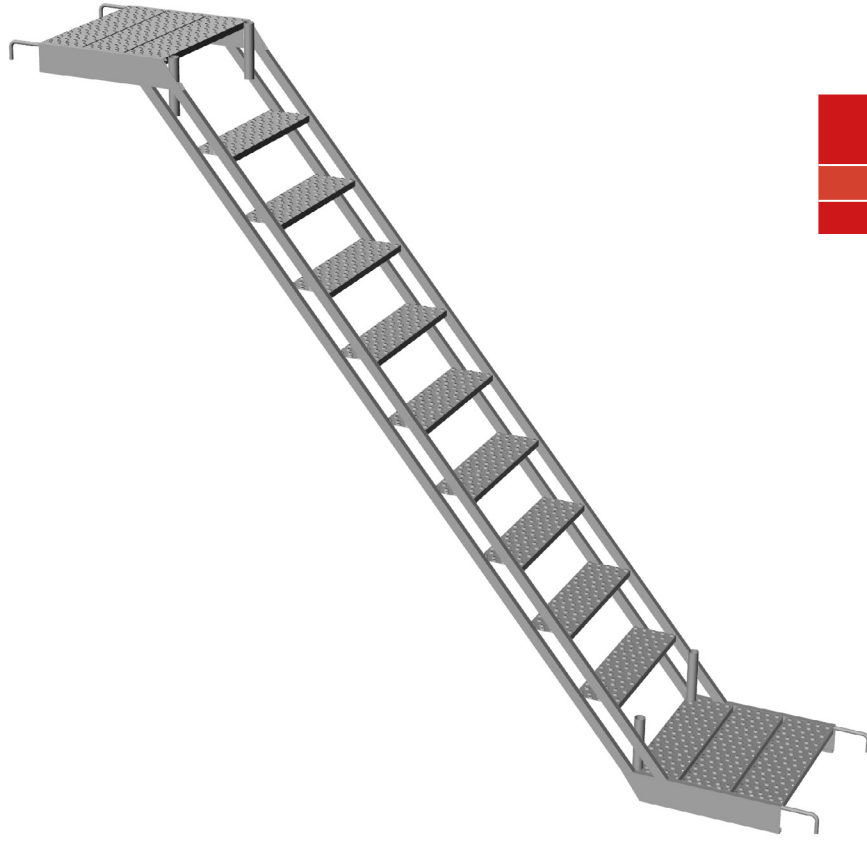

Sahanlıklı Merdiven  
Stairs With Landing

KOD CODE	BOYUT cm SIZE cm	AĞIRLIK kg WEIGHT kg
GES200	200/200	31,00
GES250	250/200	38,00

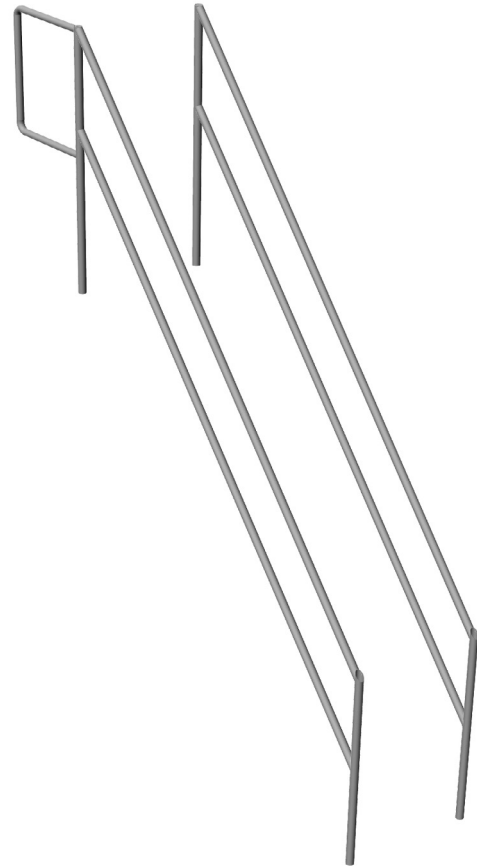

Sahanlıklı Merdiven Korkuluğu  
Stairs Hand Rail

KOD CODE	BOYUT cm SIZE cm	AĞIRLIK kg WEIGHT kg
GEQ200	200	8,80
GEQ250	250	10,40

Kapaklı Kalaslı  
Metal Plank with Trapdoor

KOD CODE	BOYUT cm SIZE cm	AĞIRLIK kg WEIGHT kg
GAD150	150	33,00
GAD200	200	36,20
GAD250	250	42,50
GAD300	300	49,30

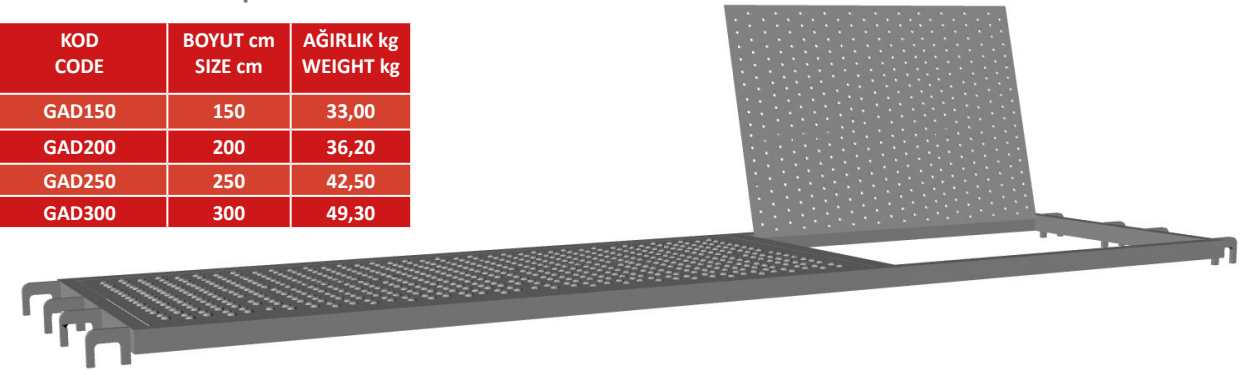

Kapaklı Kalas Merdiveni  
Ladder For Metal Plank

KOD CODE	BOYUT cm SIZE cm	AĞIRLIK kg WEIGHT kg
GAD001	200	--

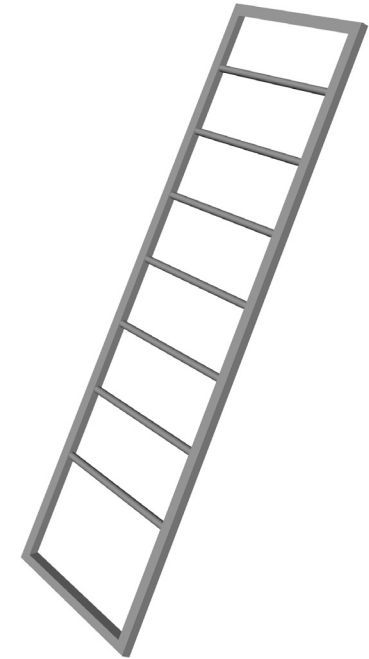

Tırmanma Merdiveni  
Ladders

KOD CODE	BOYUT cm SIZE cm	AĞIRLIK kg WEIGHT kg
GEC150	150	8,00
GEC200	200	10,00
GEC250	250	12,50
GEC300	300	15,00
GEC400	400	20,50
GEC600	600	31,00

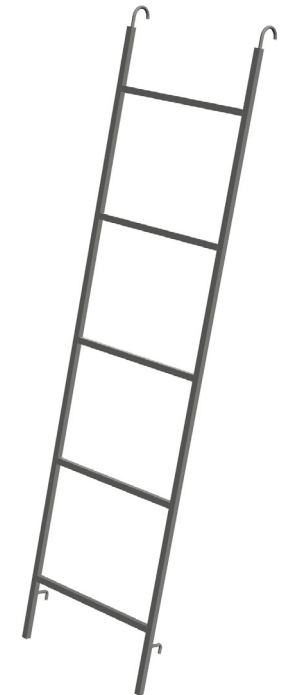



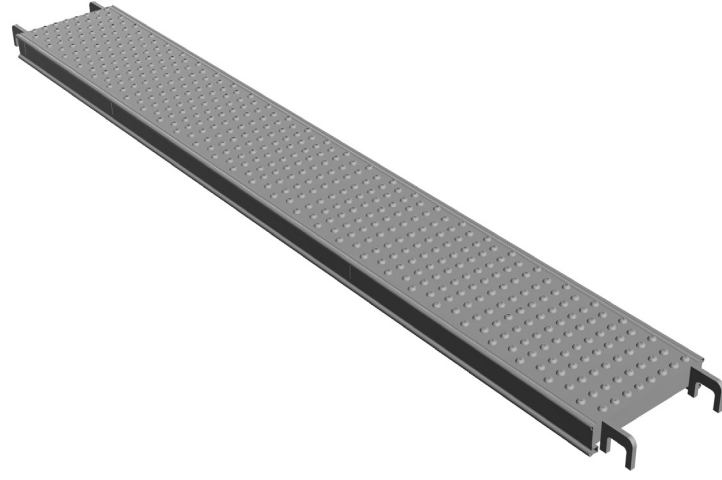

**Kalas (En 32 cm)**  
Metal Plank

KOD CODE	BOYUT cm SIZE cm	AĞIRLIK kg WEIGHT kg
GAB200	200	14,50
GAB250	250	18,20

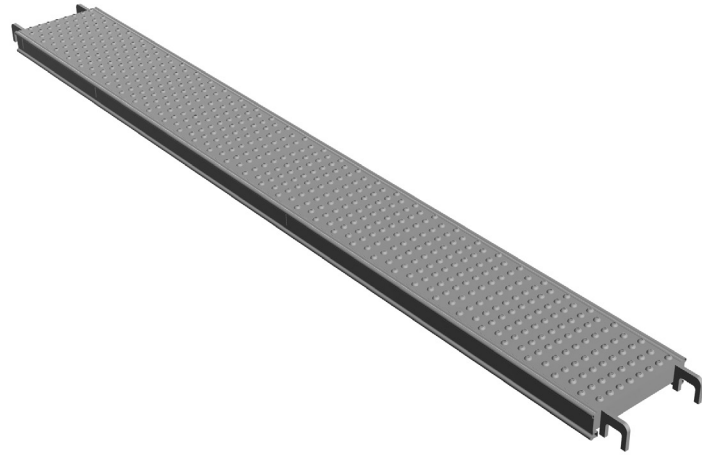

**Kalas (En 27 cm)**  
Metal Plank

KOD CODE	BOYUT cm SIZE cm	AĞIRLIK kg WEIGHT kg
GAA200	200	12,25
GAA250	250	17,50



**Omega Topukluk**  
Omega Toe Board

KOD CODE	BOYUT cm SIZE cm	AĞIRLIK kg WEIGHT kg
GAZ135	135	3,02
GAZ200	200	4,40
GAZ250	250	5,43

